

2-channel speed sensor

Sensor with current output or voltage output (standstill voltage)

GEL 2475

Technical information

Version 2024-01-29

Description

- Application-proven speed sensor using magnetic scanning
- Maintenance- and wear-free operation by contactless rotary motion measuring
- Wide measuring range for reliable detection of creeping without pulse loss and also for fast rotary motion
- Detection of direction by evaluating two channels with 90° phase offset
- Constant duty cycle of output signals

Features

- Target wheel module: 1.00 to 3.50
- Degree of protection: IP 68 sensor housing
- in accordance with DIN EN 50155:2022-06

Advantages

- Current output signals insensitive to electro-magnetic interference fields
- Cable break monitoring via current output or voltage output with standstill voltage
- Easy to install due to large measuring distance

Field of application

- Rail vehicle industry
 - Traction monitoring
 - Anti-slip protection
 - Motor speed
 - Anti-skid protection
 - Automatic train protection
 - Odometry

Do you have special requirements regarding flange shape, shaft length, number of channels, cable protection, cable outlet, connector assembly or EMC concept?

Then talk to us. Our experts can design the optimal solution for your application from an extensive modular system and will be pleased to advise you how to customize your solution in the most cost-efficient way.

Write to support@lenord.de or call +49 208 9963-215.



Voltage output

Technical data

Signal pattern	E-	S-	V-	X-	D-	H-
Electrical data						
Supply voltage U_B (reverse polarity protected)	10 to 30 V DC					
Current consumption I_B (without load)	≤ 30 mA					
Output signal (short-circuit-proof)	Square-wave signals					
Output signal level High ⁽¹⁾	$\geq U_B - 1.5$ V					
Output signal level Low ⁽¹⁾	≤ 1.0 V					
Output current per channel	≤ 20 mA					
Frequency range	0 to 20 kHz					
Duty cycle	50 % \pm 10 % ⁽²⁾					
Phase offset	–			typ. 90°		
Mechanical data						
Sensor tube material	Stainless steel					
Flange material	Stainless steel					
Sensor weight (incl. 2 m cable)	500 g					
Cable						
Connection	Cable outlet straight or at side, connector in accordance with specification					
Cable length	≤ 100 m					
Screening note	Cable screen is connected directly or, as an option, capacitively in the sensor					
Environmental testing						
Working and operating temperature	-40 °C to +120 °C					
Storage temperature	-40 °C to +120 °C					
Dielectric strength	500 V AC/750 V DC (DIN EN 50155:2022-06)					
Electromagnetic compatibility ⁽³⁾	DIN EN 50121-3-2:2017-11					
Degree of protection on measuring side ⁽⁴⁾	IP 68					
Vibration resistance	DIN EN 61373:2011-04 cat. 3					
Shock resistance	DIN EN 61373-2011-04 cat. 3					
MTTF value	2,000,000 h at 55 °C					
Requirements for the target wheel						
Material	Ferromagnetic steel					
Tooth form	Involute gear teeth as per DIN 867 (others upon request)					
Width	≥ 10 mm (smaller upon request)					
Module m	1.00/1.25/1.50/1.75/2.00/2.25/2.50/2.75/3.00/3.25/3.50					
Air gap	see air gap table, page 12					

(1) depending on output current and temperature

(2) applies to operation with nominal air gap and tooting as per DIN 867

(3) Observe EMC notes in the mounting/operating instructions

(4) Degree of protection on the cable outlet side depends on cable gland or cable protection

Voltage output Cable data

Signal patterns E-, S- and V-

Cable data	
Cable	halogen-free and screened ⁽¹⁾
Cable diameter	5.4 ± 0.2 mm
Cable cross section	4 × 0.5 mm ²
Minimum bending radius static/dynamic	16 mm / 27 mm

Signal pattern X-

Cable data	
Cable	halogen-free and screened ⁽¹⁾
Cable diameter	6.5 ± 0.3 mm
Cable cross section	6 × 0.5 mm ²
Minimum bending radius static/dynamic	20 mm / 33 mm

Signal patterns D- and H-

Cable data	
Cable	halogen-free, screened ⁽¹⁾
Cable diameter	8.0 ± 0.3 mm
Cable cross section	12 × 0.34 mm ²
Minimum bending radius static/dynamic	24 mm / 40 mm

⁽¹⁾ Specification upon request

Voltage output

Output signals and connection

Signal pattern for voltage output (E-, S-, V-, X-, D-, H-)

Output signals		Supply voltage	Pulse diagram
E-	1 channel	10 to 30 V DC	
S-	1 channel with directional signal forward backward	10 to 30 V DC	
V-	2 channels, 90° phase offset	10 to 30 V DC	
X-	2 channels, 90° phase offset, with inverse channels	10 to 30 V DC	
D-	2 channels, electrically isolated, 90° phase offset	10 to 30 V DC	
H-	2 channels, electrically isolated, 90° phase offset, with inverse channels	10 to 30 V DC	

Output signal level – voltage output (E-, S-, V-, X-, D-, H-)

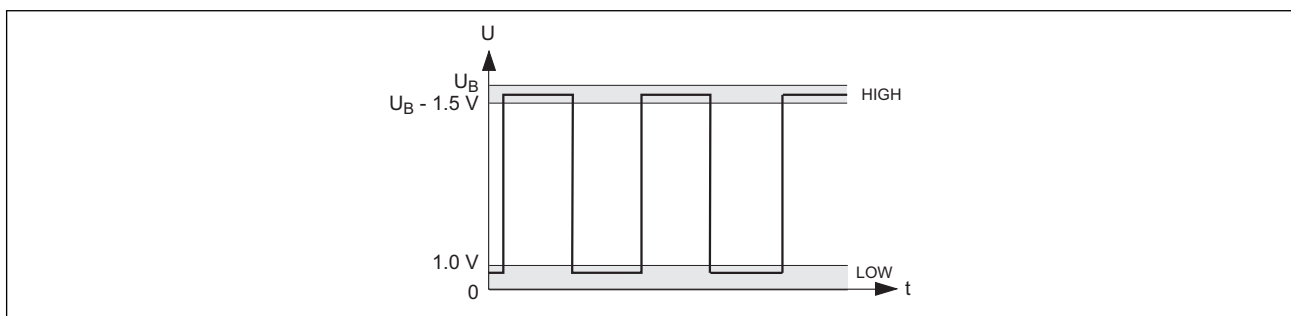

Pin assignment – voltage output (E-, S-, V-, X-, D-, H-)

Signal	E-	S-	V-	X-	D-		H-	
Channel 1	YE	YE	YE	YE	YE		YE	
Channel 2		WH	WH	WH		WH		WH
Channel 1 inverse				BK			BK	
Channel 2 inverse				BN				BN
GND (0 V)	BU	BU	BU	BU	BU	GY	BU	GY
+ U_B	RD	RD	RD	RD	RD	PK	RD	PK
Cables/Screens	1 / 1	1 / 1	1 / 1	1 / 1	1 / 1		1 / 1	

Cable screen is connected directly or, as an option, capacitively in the sensor
 Core identifier: **BK** black, **BN** brown, **BU** blue, **GY** grey, **PK** pink, **RD** red, **WH** white, **YE** yellow

Voltage output with standstill voltage

Technical data

	EM	DM
Electrical data		
Supply voltage U_B (reverse polarity protected)	10 to 20 V DC	
Current consumption I_B (without load)	≤ 12 mA per channel	
Output signal (short-circuit-proof)	Square-wave signals	
Output signal level High ⁽¹⁾	$\geq U_B - 1.8$ V	
Output signal level Low ⁽¹⁾	≤ 1.5 V	
Output current per channel	≤ 10 mA	
Frequency range	0 to 8 kHz	
Duty cycle	50 % \pm 10 % ⁽²⁾	
Phase offset	–	typ. 90°
Mechanical data		
Sensor tube material	Stainless steel	
Flange material	Stainless steel	
Sensor weight (incl. 2 m cable)	500 g	
Cable		
Cable	halogen-free and screened ⁽³⁾	
Cable diameter	5.4 \pm 0.2 mm	8.0 \pm 0.3 mm
Cable cross section	4 x 0.5 mm ²	12 x 0.34 mm ²
Minimum bending radius static/dynamic	16 mm/27 mm	24 mm/40 mm
Screening note	Cable screen is connected directly or, as an option, capacitively in the sensor	
Environmental testing		
Working and operating temperature	-40 °C to +85 °C	
Storage temperature	-40 °C to +120 °C	
Dielectric strength	500 V AC/750 V DC (DIN EN 50155:2022-06)	
Electromagnetic compatibility ⁽⁴⁾	DIN EN 50121-3-2:2017-11	
Degree of protection on measuring side ⁽⁵⁾	IP 68	
Vibration resistance	DIN EN 61373:2011-04 cat. 3	
Shock resistance	DIN EN 61373-2011-04 cat. 3	
MTTF value	2,000,000 h at 55 °C	
Requirements for the target wheel		
Material	Ferromagnetic steel	
Tooth form	Involute gear teeth as per DIN 867 (others upon request)	
Width	≥ 10 mm (smaller upon request)	
Module m	1.00/1.25/1.50/1.75/2.00/2.25/2.50/2.75/3.00/3.25/3.50	
Air gap	see air gap table, page 12	

(1) depending on output current and temperature

(2) applies to operation with nominal air gap and toothing as per DIN 867

(3) Specification upon request

(4) Observe EMC notes in the mounting/operating instructions

(5) Degree of protection on the cable outlet side depends on cable gland or cable protection

Voltage output with standstill voltage output signals and connection

Signal pattern with standstill voltage (EM, DM)

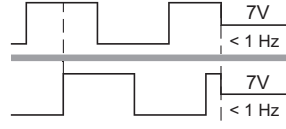
Output signals		Supply voltage	Pulse diagram
EM	1 channel with standstill voltage	10 to 20 V DC	
DM	2 channels, electrically isolated, 90° phase offset, with standstill voltage	2 × 10 to 20 V DC	

Output signal level – voltage output (EM, DM)

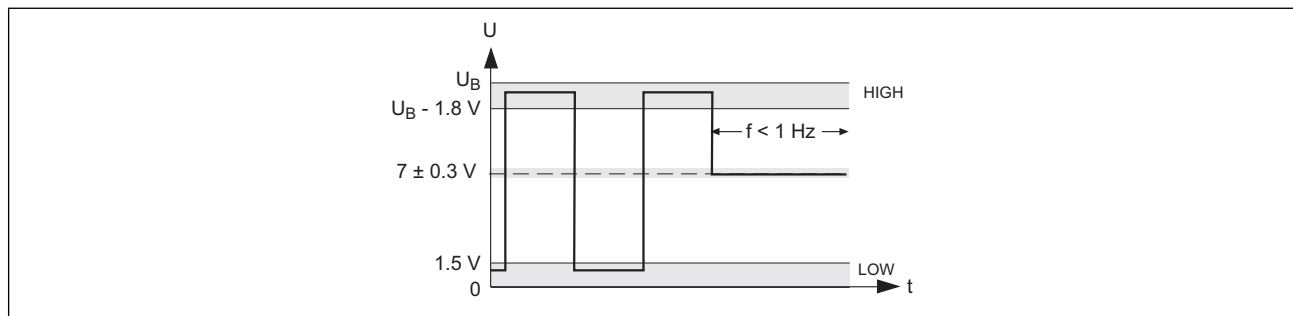

Pin assignment – voltage output (EM, DM)

Signal	EM	DM	
Channel 1	YE	YE	
Channel 2			WH
GND (0 V)	BU	BU	GY
+ U_B	RD	RD	PK
Cables/Screens	1 / 1	1 / 1	

Cable screen is connected directly or, as an option, capacitively in the sensor

Core identifier: **BU** blue, **GY** grey, **PK** pink, **RD** red, **WH** white, **YE** yellow

Current output

Technical data

	EI	VI	DI
Electrical data			
Supply voltage U_B (reverse polarity protected)	10 to 20 V DC		
Output signal (short-circuit-proof)	Square-wave signals		
Output signal level High ⁽¹⁾	typ. 14 mA		
Output signal level Low ⁽¹⁾	typ. 6 mA		
Output current per channel	≤ 16 mA		
Frequency range	0 to 12 kHz		
Duty cycle	50 % ± 10 % ⁽²⁾		
Phase offset	–	typ. 90°	
Mechanical data			
Sensor tube material	Stainless steel		
Flange material	Stainless steel		
Sensor weight (incl. 2 m cable)	500 g		
Cable			
Cable	halogen-free and screened ⁽³⁾		
Cable diameter	5.4 ± 0.2 mm		
Cable cross section	4 x 0.5 mm ²		
Minimum bending radius static/dynamic	16 mm/27 mm		
Screening note	Cable screen is connected directly or, as an option, capacitively in the sensor		
Environmental testing			
Working and operating temperature	-40 °C to +120 °C		
Storage temperature	-40 °C to +120 °C		
Dielectric strength	500 V AC/750 V DC (DIN EN 50155:2022-06)		
Electromagnetic compatibility ⁽⁴⁾	DIN EN 50121-3-2:2017-11		
Degree of protection on measuring side ⁽⁵⁾	IP 68		
Vibration resistance	DIN EN 61373:2011-04 cat. 3		
Shock resistance	DIN EN 61373-2011-04 cat. 3		
MTTF value	2,000,000 h at 55 °C		
Requirements for the target wheel			
Material	Ferromagnetic steel		
Tooth form	Involute gear teeth as per DIN 867 (others upon request)		
Width	≥ 10 mm (smaller upon request)		
Module m	1.00/1.25/1.50/1.75/2.00/2.25/2.50/2.75/3.00/3.25/3.50		
Air gap	see air gap table, page 12		

(1) depending on output current and temperature

(2) applies to operation with nominal air gap and toothing as per DIN 867

(3) Specification upon request

(4) Observe EMC notes in the mounting/operating instructions

(5) Degree of protection on the cable outlet side depends on cable gland or cable protection

Current output output signals and connection

Signal pattern (EI, VI, DI)

Output signals		Supply voltage	Pulse diagram
EI	1 channel	10 to 20 V DC	
VI	2 channels, 90° phase offset	10 to 20 V DC	
DI	2 channels, electrically isolated, 90° phase offset	2 x 10 to 20 V DC	

Output signal level (EI, VI, DI)

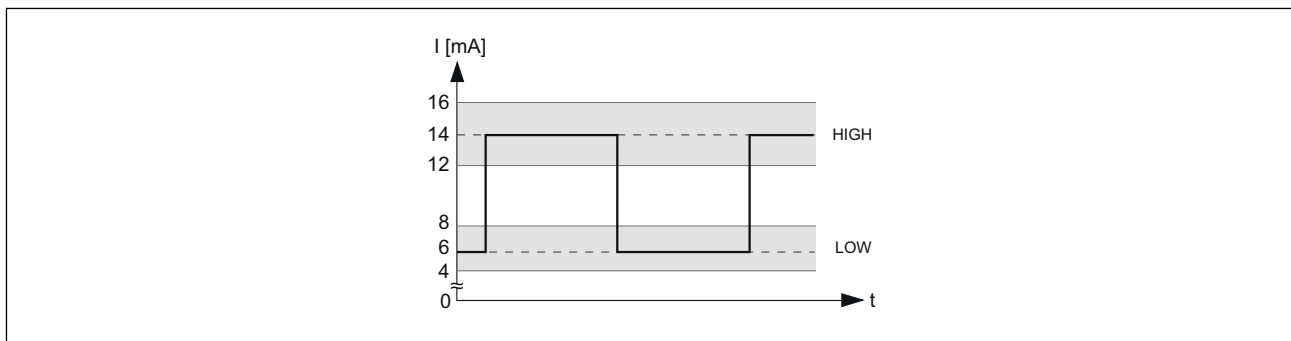

Core assignment (EI, VI, DI)

Signal	EI	VI	DI	
Channel 1	BU	BU	BU	
Channel 2		GN		GN
+U _B	RD	RD	RD	YE
Cables/Screens		1 / 1	1 / 1	

Cable screen is connected directly or, as an option, capacitively in the sensor

Core identifier: **BU** blue, **RD** red, **GN** green, **YE** yellow

GEL 247x

U_B Supply voltage
S Signal

Measuring resistor

The measuring resistor R_B to be connected at the current output must not exceed or fall below a certain value. The following relation applies:

$$R_{B, \max} = (U_B - 5 \text{ V}) / I_{\max}$$

with U_B = 10 to 20 V DC and I_{max} = 16 mA

Example for U_B = 15 V:

$$R_{B, \max} = 10 \text{ V} / 16 \text{ mA} = 625 \Omega$$

$$R_{B, \min} = 240 \Omega$$

Technical drawings

All dimensions in mm, general tolerance DIN ISO 2768 mK

Dimensional drawing

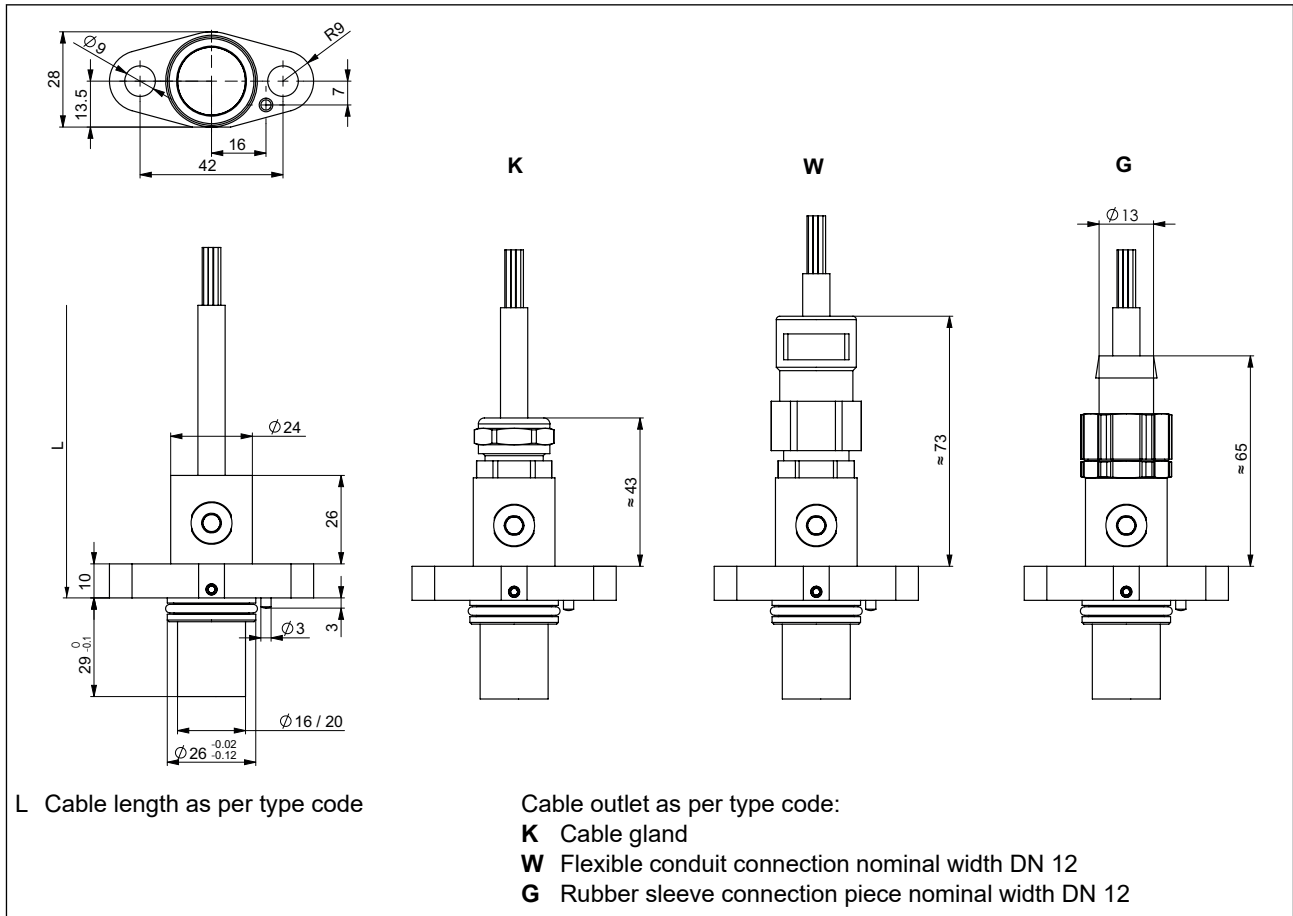

Cable screen is connected directly or, as an option, capacitively in the sensor
Observe EMC notes in the mounting instructions.

Technical drawings

All dimensions in mm, general tolerance DIN ISO 2768 mK

Assembly drawing

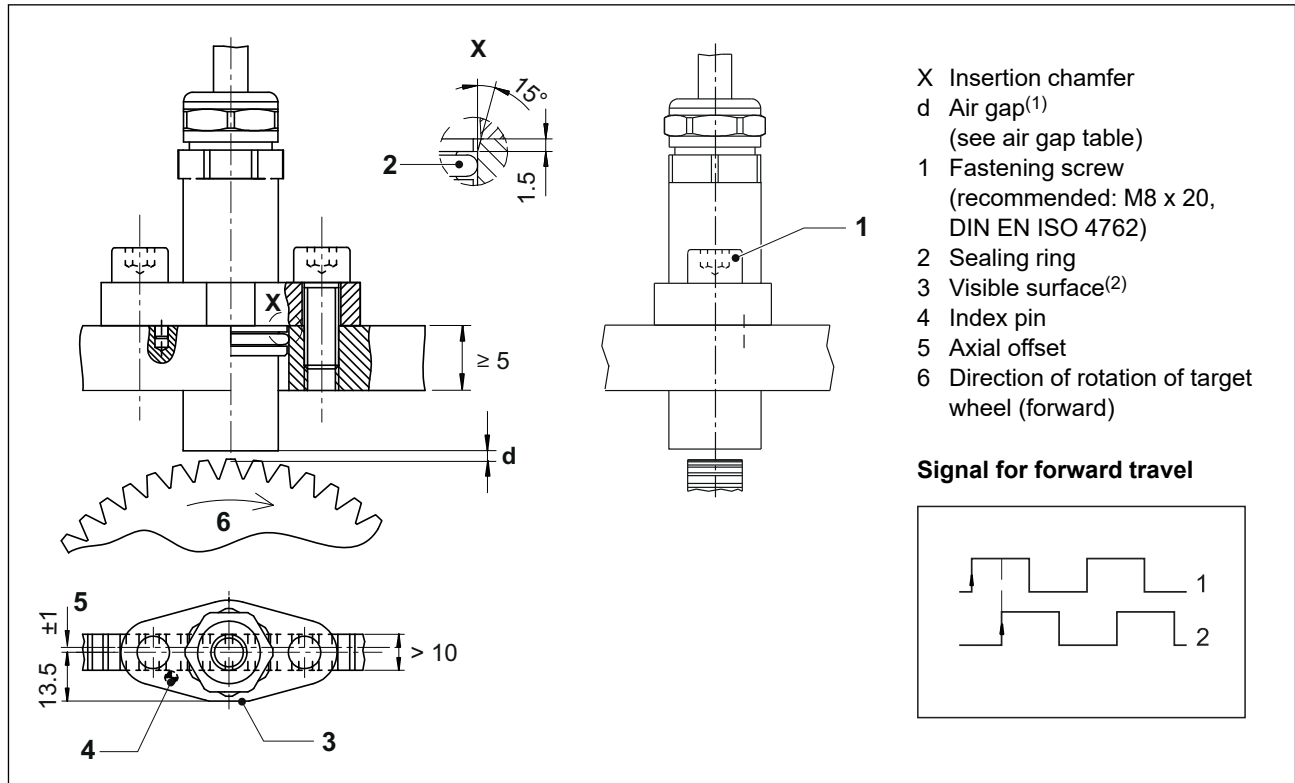

(1) depending on signal pattern and module

(2) Looking at the visible surface, the signals are output forward when the target wheel rotates clockwise.

Technical drawings

All dimensions in mm, general tolerance DIN ISO 2768 mK

Hole pattern

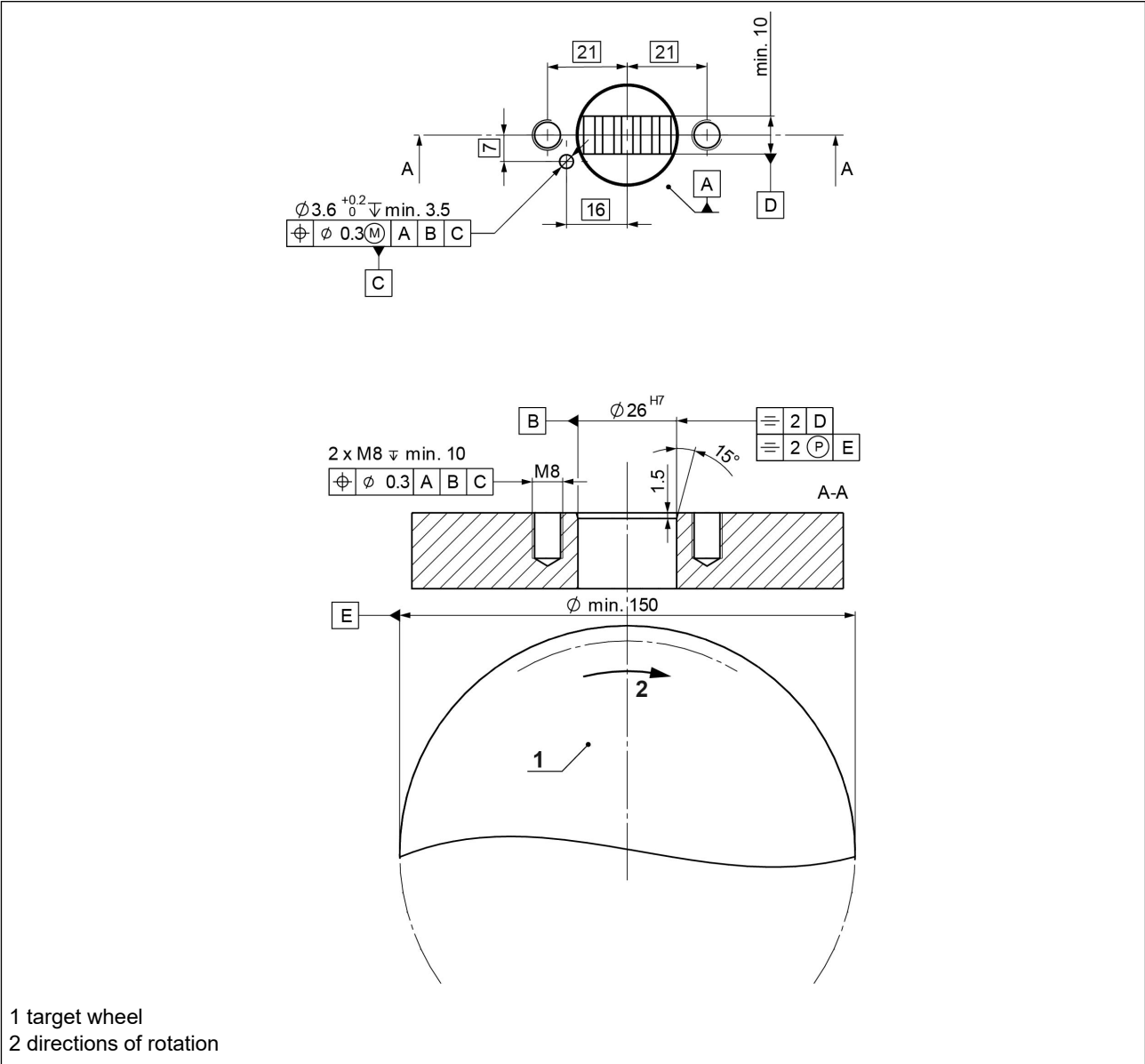

Air gap table

Air gap table

Module	Permissible air gap	Nominal air gap	max. permissible radial runout
1.00	0.2 to 1.4 mm	0.5 mm	± 0.3 mm
1.25			
1.50	0.2 to 1.8 mm	0.7 mm	
1.75			
2.00	0.2 to 2.2 mm	0.7 mm	
2.25			
2.50	0.2 to 2.8 mm		
2.75			
3.00			
3.25			
3.50			
	0.2 to 3.0 mm		

Type code GEL 2475

Signal pattern	
E	1-channel square-wave signals
S	1-channel square-wave signals with directional signal
V	2-channel square-wave signals with 90° phase offset
X	2-channel square-wave signals with 90° phase offset and their inverse signals
D	2-channel square-wave signals with 90° phase offset, electrically isolated
H	2-channel square-wave signals with 90° phase offset and their inverse signals, electrically isolated
Signal output	
-	Voltage
I	Current 6 to 14 mA (only with signal pattern D, E and V)
M	Voltage, with standstill voltage 7 V (only with signal pattern D and E)
Module m	
100	m= 1.00
125	m= 1.25
150	m= 1.50
175	m= 1.75
200	m= 2.00
225	m= 2.25
250	m= 2.50
275	m= 2.75
300	m= 3.00
325	m= 3.25
350	m= 3.50
Cable screen	
L	Cable screen is connected to the sensor housing
P	Cable screen is connected capacitively to the sensor housing
Cable outlet	
K	Cable gland
W	Flexible conduit connection DN 12
G	Rubber sleeve connection piece DN 12
Cable length L	
xxxx	cm Cable length
Tailoring	
N	Standard design
S	Special design
2475	

Note: A Y-number is assigned for a customer-specific special version. A special design GEL 2475Yxxx is manufactured according to drawing or application description.

We can manufacture according to your specifications:

Examples for the sensor side, preferred types

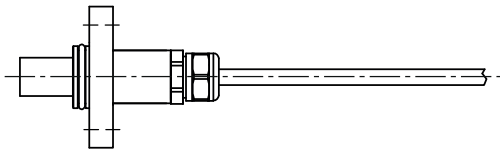

Standard, cable outlet straight

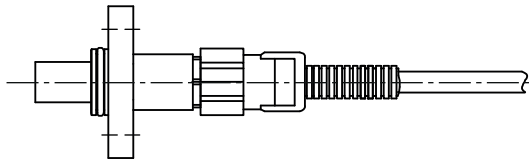

*ABB flexible conduit, cable outlet straight
Type XPCST-12BG*

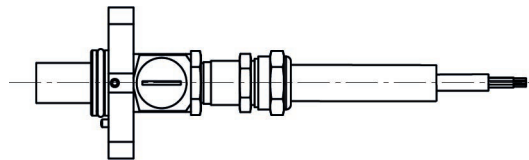

*Anaconda Sealite, cable outlet straight
Type HFX-V0 348.010.1 5/16"*

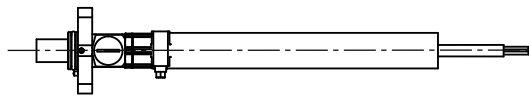

*EATON hose, cable outlet straight
Type EC 045-8*

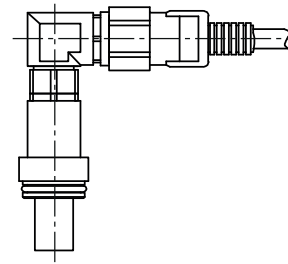

Cable outlet with 90° angle and flexible conduit

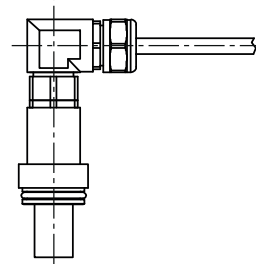

Cable outlet with 90° angle

Examples for the flying lead, preferred types

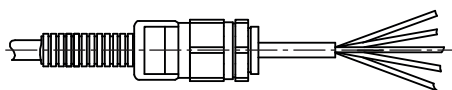

Flexible conduit and flying lead

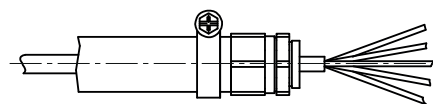

Rubber sleeve and flying lead

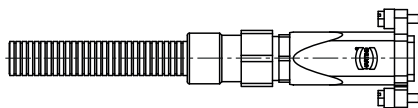

Flexible conduit with Harting connector HAN HPR

Pin assignment Harting connector HAN HPR, preferred type

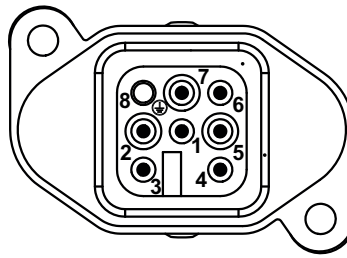

Pin	E-	S-	V-	X-	D-	EM	DM	EI	VI	DI
1	+U _{B1}	+U _{B1}	+U _{B1}	+U _{B1}	+U _{B1}	+U _{B1}	+U _{B1}	+U _{B1}	+U _{B1}	+U _{B1}
2	GND1	GND1	GND1	GND1	GND1	GND1	GND1	Channel 1	Channel 1	Channel 1
3	Channel 1	Channel 1	Channel 1	Channel 1	Channel 1	Channel 1	Channel 1	-	-	-
4	-	Channel 2	Channel 2	Channel 2	Channel 2	-	Channel 2	-	-	-
5	-	-	-	Channel 1 inverse	GND2	-	GND2	-	Channel 2	Channel 2
6	-	-	-	Channel 2 inverse	-	-	-	-	-	-
7	-	-	-	-	+U _{B2}	-	+U _{B2}	-	-	+U _{B2}
8	Screen	Screen	Screen	Screen	Screen	Screen	Screen	Screen	Screen	Screen

If you decide to have our speed sensors assembled with cable protection and connectors, we recommend using the preferred types shown in the figure. The required materials are field-tested in large quantities and are always in stock. This guarantees the fastest delivery times with the best material availability and the lowest prices due to large purchasing volumes.

If you need help in finding the product you need, please contact our internal sales team at support@lenord.de or call +49 208 9963-215.



Lenord, Bauer & Co. GmbH
Dohlenstraße 32
46145 Oberhausen, Germany
Phone: +49 208 9963-0
Fax: +49 208 676292
Internet: www.lenord.com
E-Mail: info@lenord.de