

Description

- Application approved speed sensor based on magnetic
- Maintenance- and wear-free operation due to contactless measurement of rotation
- Scans measuring scales made of ferromagnetic materials, e. g. toothed wheels
- Safe acquisition of creeping movements without loss of pulses from 0 Hz
- Two channels shifted by 90° provide the direction of rotation
- Robust and compact stainless steel housing suitable for harsh application
- Constant duty output signals
- Customised cable fittings

Features

- Module of measuring scale: 1.00 to 3.50
- Degree of protection: IP 68 sensor housing
- In accordance with DIN EN 50155:2022-06

Advantages

- Low lifecycle costs for the vehicle operator due to high reliability
- Place-saving sensor in a compact design

Fields of application

- Rail vehicles
 - Traction control
 - Anti slip
 - Motor speed
 - Wheel slide protection
 - Automatic train protection
 - Odometry

Do you have special requirements on the shape of the flange, tube length, number of channels, cable protection, cable outlet, connector assembly or the EMC concept?

Contact us. Our experts can create the optimal solution for your application from an extensive modular system and would be pleased to advise you on customer-specific modifications for the greatest possible cost efficiency.

support@lenord.de or +49(0)208 9963-215

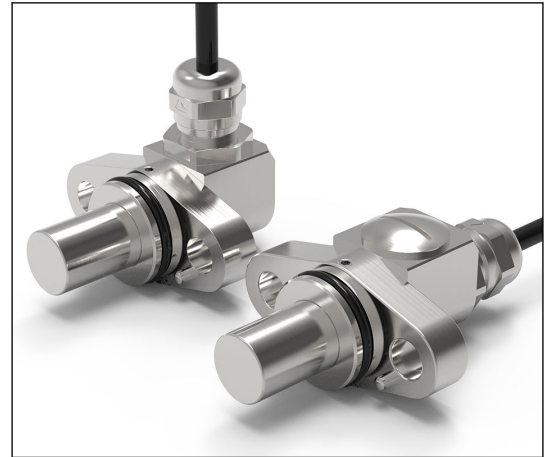

Lateral or straight cable outlet

Right to technical changes and errors reserved.

Voltage output

Technical data

Signal pattern	E-	F-	S-	V-	X-	D-	H-
Electrical data							
Supply voltage U_B (reverse battery protected)	10 to 30 V DC						
Current consumption I_B (no load)	≤ 15 mA			≤ 25 mA			
Output signal (short circuit-proof)	square-wave signals						
Output signal level high ⁽¹⁾	$\geq U_B - 1.0$ V						
Output signal level low ⁽¹⁾	≤ 1.0 V						
Output current per channel	≤ 20 mA						
Frequency range	0 to 25 kHz						
Duty cycle	50% \pm 20% ⁽²⁾						
Phase shift	–			typ. 90°			
Mechanical data							
Sensor tube material	stainless steel						
Flange material	stainless steel						
Weight of sensor (incl. 2 m cable)	500 g						
Cable							
Connection	Cable outlet straight or side, connector by arrangement						
Cable length	≤ 100 m						
Information on screening	Cable screen connected directly in the sensor or optionally connected capacitively						
Environmental tests							
Working and operating temperature	-40 °C to +120 °C						
Storage temperature	-40 °C to +120 °C						
Dielectric strength	750 V DC (DIN EN 50155:2022-06)						
Electromagnetic compatibility	DIN EN 50121-3-2:2017-11						
Degree of protection on the measuring side ⁽³⁾	IP X8						
Vibration resistance	DIN EN 61373:2011-04 Kat. 3						
Shock resistance	DIN EN 61373-2011-04 Kat. 3						
MTTF value	2,000,000 h at 55 °C						
Requirements on target wheels							
Material	ferromagnetic steel						
Teeth form	involute gear as per DIN 867 (on request)						
Width	≥ 10 mm (smaller ones upon request)						
Module m	1.00 / 1.25 / 1.50 / 1.75 / 2.00 / 2.25 / 2.50 / 2.75 / 3.00 / 3.25 / 3.50						
Air gap	see air gap table on page 11						





⁽¹⁾ Depends on output current and temperature

⁽²⁾ Applies to operation with nominal air gap and teeth in accordance with DIN 867

⁽³⁾ Degree of protection of the cable outlet side is dependent on the cable gland or cable protection

Voltage output Output signals

Signal pattern

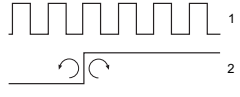
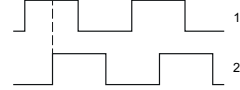
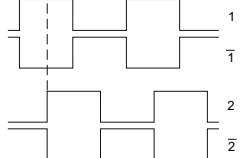
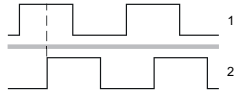
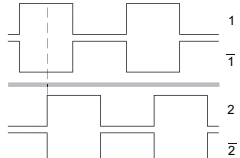
Output signals		Supply voltage	Pulse diagram
E-	1 channel	10 to 30 V DC	
F-	1 channel with inverse signals	10 to 30 V DC	
S-	1 channel with direction detection signal  forward  backward	10 to 30 V DC	
V-	2 channels, 90° phase offset	10 to 30 V DC	
X-	2 channels, 90° phase offset, with inverse signals	10 to 30 V DC	
D-	2 channels, galvanically isolated, 90° phase offset	10 to 30 V DC	
H-	2 channels, galvanically isolated, 90° phase offset, with inverse signals	10 to 30 V DC	

Output signal level — voltage output

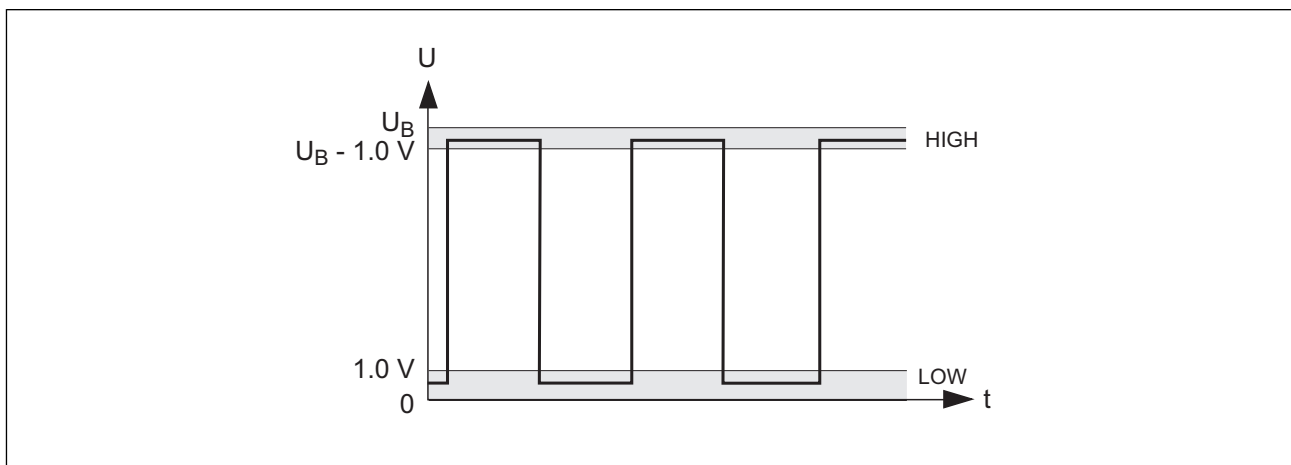

Connection

Preferred cable

Signal pattern E-, S- and V-

Cable data	
Cable	halogenfree and screened ⁽¹⁾
Cable diameter	5.4 ± 0.2 mm
Cross section	4 × 0.5 mm ²
Minimum bending radius static/dynamic	16 mm / 27 mm

Signal pattern F- and X-

Cable data	
Cable	halogenfree and screened ⁽¹⁾
Cable diameter	6.5 ± 0.3 mm
Cross section	6 × 0.5 mm ²
Minimum bending radius static/dynamic	20 mm / 33 mm

Signal pattern D- and H-

Cable data	
Cable	halogenfree and screened ⁽¹⁾
Cable diameter	8.0 ± 0.3 mm
Cross section	12 × 0.34 mm ²
Minimum bending radius static/dynamic	24 mm / 40 mm

Connection assignment

Follow instructions on EMC in the assembly/operating instructions.

Cable end: flying lead

Signal	E-	F-	S-	V-	X-	D-		H-	
Channel 1	YE	YE	YE	YE	YE	YE		YE	
Channel 2			WH	WH	WH		WH		WH
Channel 1 inverse		BK			BK			BK	
Channel 2 inverse					BN				BN
GND (0 V)	BU	BU	BU	BU	BU	BU	GY	BU	GY
+U _B	RD	RD	RD	RD	RD	RD	PK	RD	PK
Cable / shields	1 / 1	1 / 1	1 / 1	1 / 1	1 / 1	1 / 1		1 / 1	

Cable screen connected directly in the sensor or optionally connected capacitively

Core identification: **BK** black, **BN** brown, **BU** blue, **GY** grey, **PK** pink, **RD** red, **WH** white, **YE** yellow

⁽¹⁾ specification upon request

Voltage output with standstill voltage

Technical data

	DM	EM
Electrical data		
Supply voltage U_B (reverse battery protected)	10 to 30 V DC	
Current consumption I_B (no load)	≤ 12 mA per channel	
Output signal (short circuit-proof)	square-wave signals	
Output signal level high ⁽¹⁾	≥ $U_B - 1.8$ V	
Output signal level low ⁽¹⁾	≤ 1.5 V	
Output current per channel	≤ 10 mA	
Frequency range	0 to 20 kHz	
Duty cycle	50% ± 20% ⁽²⁾	
Phase shift	typ. 90°	–
Mechanical data		
Sensor tube material	stainless steel	
Flange material	stainless steel	
Weight of sensor (incl. 2 m cable)	500 g	
Cable		
Cable	halogenfree and screened ⁽³⁾	
Cable diameter	8.0 ± 0.3 mm	5.4 ± 0.3 mm
Cross section	12 x 0.34 mm ²	4 x 0.5 mm ²
Minimum bending radius static/dynamic	24 mm / 40 mm	16 mm / 27 mm
Information on screening	Cable screen connected directly in the sensor or optionally connected capacitively	
Environmental tests		
Working and operating temperature	-40 °C to +85 °C	
Storage temperature	-40 °C to +120 °C	
Dielectric strength	750 V DC (DIN EN 50155:2022-06)	
Electromagnetic compatibility	DIN EN 50121-3-2:2017-11	
Degree of protection on the measuring side ⁽⁴⁾	IP X8	
Vibration resistance	DIN EN 61373:2011-04 Kat. 3	
Shock resistance	DIN EN 61373-2011-04 Kat. 3	
MTTF-Wert	2,000,000 h at 55 °C	
Requirements on target wheels		
Material	ferromagnetic steel	
Teeth form	involute gear as per DIN 867 (on request)	
Width	≥ 10 mm (smaller ones upon request)	
Module m	1.00 / 1.25 / 1.50 / 1.75 / 2.00 / 2.25 / 2.50 / 2.75 / 3.00 / 3.25 / 3.50	
Air gap	see air gap table on page 11	

⁽¹⁾ Depends on output current and temperature



⁽²⁾ Applies to operation with nominal air gap and teeth in accordance with DIN 867

⁽³⁾ Specification upon request

⁽⁴⁾ Degree of protection of the cable outlet side is dependent on the cable gland or cable protection

Voltage output with standstill voltage – output signals and connection

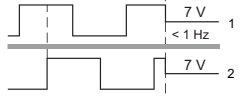
Signal pattern with standstill voltage(DM, EM)

Output signals		Supply voltage	Pulse diagram
DM	2-channels galvanically isolated, 90° phase shift with standstill voltage	2 x 10 to 30 V DC	
EM	1-channel with standstill voltage	10 to 30 V DC	

Output signal level – voltage output (DM, EM)

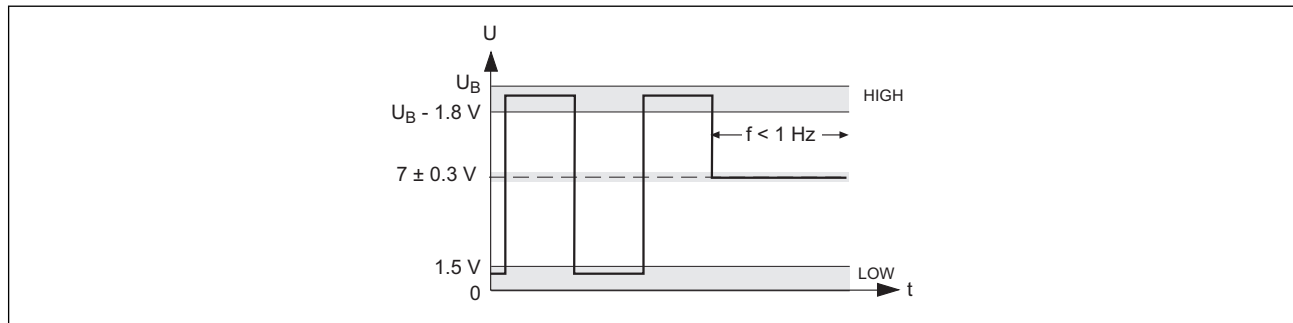

Connection assignment – voltage output (DM, EM)

Signal	DM		EM
Channel 1	YE		YE
Channel 2		WH	
GND (0 V)	BU	GY	BU
+ U_B	RD	PK	RD
Cable / Screen	1 / 1		1 / 1
Cable screen connected directly in the sensor or optionally connected capacitively			

Current output

Technical data

	DI	VI	EI
Electrical data			
Supply voltage U_B (reverse battery protected)	10 to 30 V DC		
Output signal (short circuit-proof)	square-wave signals		
Output signal level high ⁽¹⁾	typ. 14 mA		
Output signal level low ⁽¹⁾	typ. 7 mA		
Output current per channel	≤ 16 mA		
Frequency range	0 to 25 kHz		
Duty cycle	50% ± 20% ⁽²⁾		
Phase shift	typ. 90°		–
Mechanical data			
Sensor tube material	stainless steel		
Flange material	stainless steel		
Weight of sensor (incl. 2 m cable)	500 g		
Cable			
Cable	halogenfree and screening ⁽³⁾		
Cable diameter	5.4 ± 0.3 mm		
Cross section	4 x 0.5 mm ²		
Minimum bending radius static/dynamic	16 mm / 27 mm		
Information on screening	Cable screen connected directly in the sensor or optionally connected capacitively		
Environmental tests			
Working and operating temperature	-40 °C to +85 °C		
Storage temperature	-40 °C to +120 °C		
Dielectric strength	750 V DC (DIN EN 50155:2022-06)		
Electromagnetic compatibility	DIN EN 50121-3-2:2017-11		
Degree of protection on the measuring side ⁽⁴⁾	IP X8		
Vibration resistance	DIN EN 61373:2011-04 Kat. 3		
Shock resistance	DIN EN 61373-2011-04 Kat. 3		
MTTF-Wert	2,000,000 h at 55 °C		
Requirements on target wheels			
Material	ferromagnetic steel		
Teeth form	involute gear as per DIN 867 (on request)		
Width	≥ 10 mm (smaller ones upon request)		
Module m	1.00 / 1.25 / 1.50 / 1.75 / 2.00 / 2.25 / 2.50 / 2.75 / 3.00 / 3.25 / 3.50		
Air gap	see air gap table on page 11		

(1) Depends on output current and temperature

(2) Applies to operation with nominal air gap and teeth in accordance with DIN 867

(3) Specification upon request

(4) Degree of protection of the cable outlet side is dependent on the cable gland or cable protection

Current output

Output signals and connection

Signal pattern

Output signals		Supply voltage	Pulse diagram
EI	1-channel	10 ... 30 V DC	
VI	2-channels, 90° phase shift	10 ... 30 V DC	
DI	2-channels galvanically isolated, 90° phase shift	2 x 10 ... 30 V DC	

Output signal level

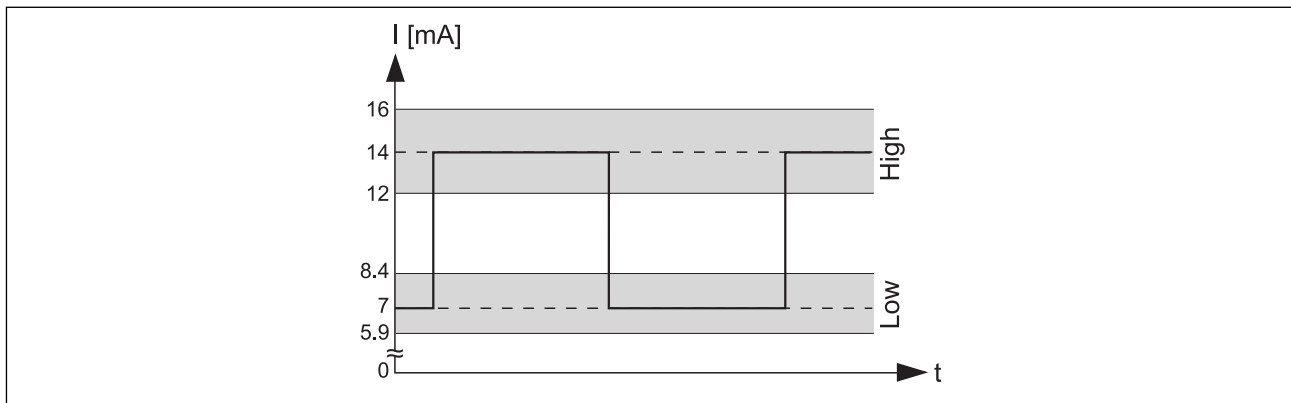

Connection assignment

Signal	VI	EI	DI	
Channel 1	blue	blue	blue	
Channel 2	green			green
+ U_B	red	red	red	yellow
Cable / Screen	1 / 1		1 / 1	

Cable screen connected directly in the sensor or optionally connected capacitively

GEL 247x

U_B supply voltage
S signal

Measuring resistor

The measuring resistor R_B to be connected to the current output is not allowed to be less than or greater than a specific value. The following relationship applies:

$$R_{B,max} = (U_B - 5 V) / I_{max}$$

with $U_B = 10$ to 30 V DC and $I_{max} = 16$ mA

Example for $U_B = 15$ V:

$$R_{B,max} = 10 V / 16 mA = 625 \Omega$$

$$R_{B,min} = 240 \Omega$$

Technical drawings

All dimensions stated in mm, general tolerance DIN ISO 2768 mK

Dimensions preferred types

Cable outlet straight (Option F cable length standard)

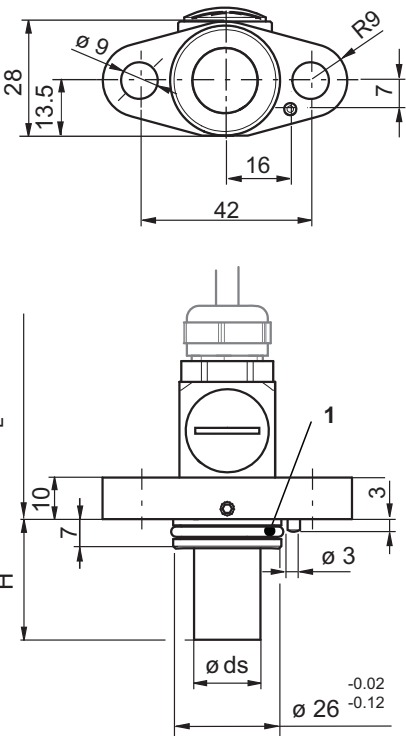

Cable outlet side (Option G cable length standard)

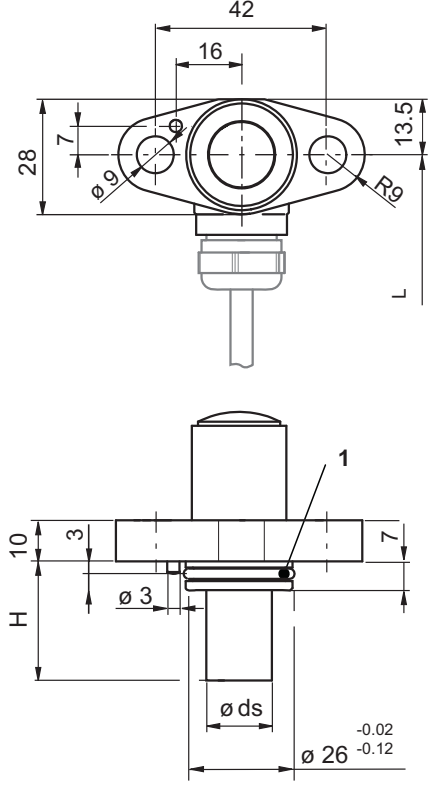

Cable end: flying lead

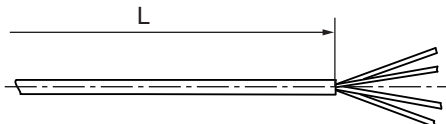

L 2000 mm

1 Sealing ring:

Dimensions

H [mm] (a)	$\varnothing ds$ [mm]
29 _{-0,1}	16
(a) other lengths available upon request	

For other cable lengths, select the option S (straight) or T (side) and state the cable length with the order.

Technical drawings

All dimensions stated in mm, general tolerance DIN ISO 2768 mK

Assembly drawing

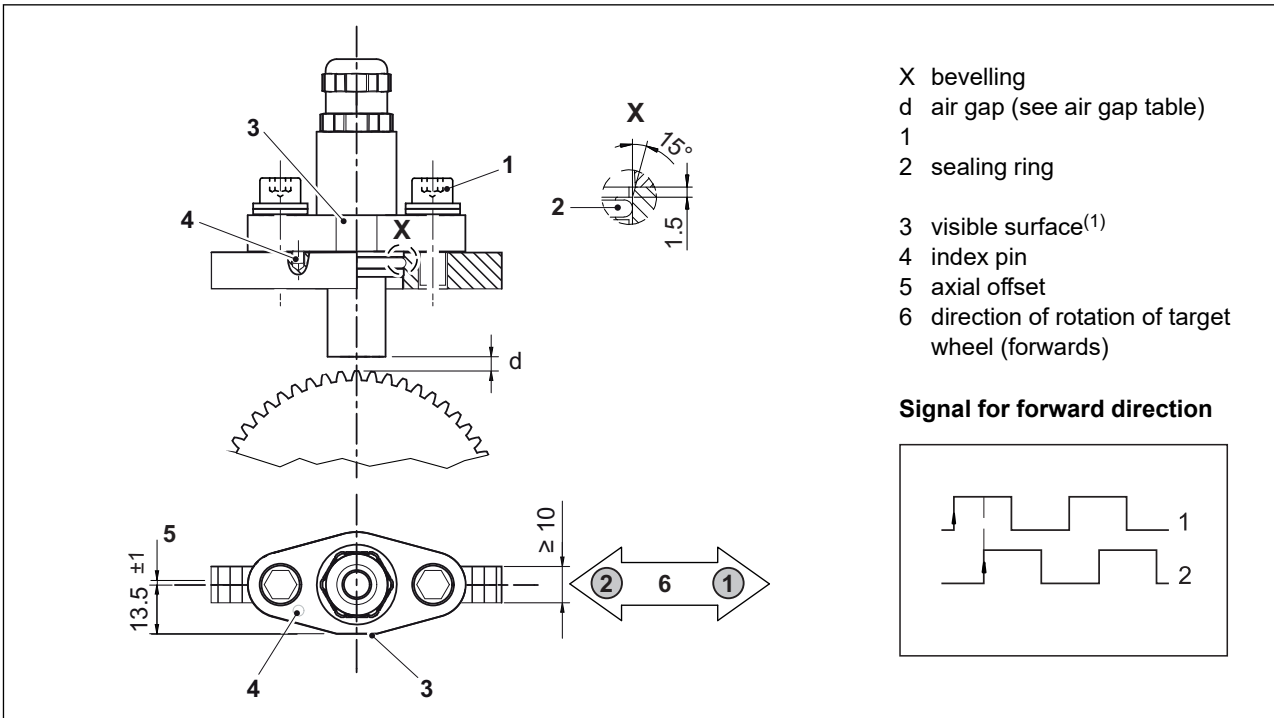

Drilling plan

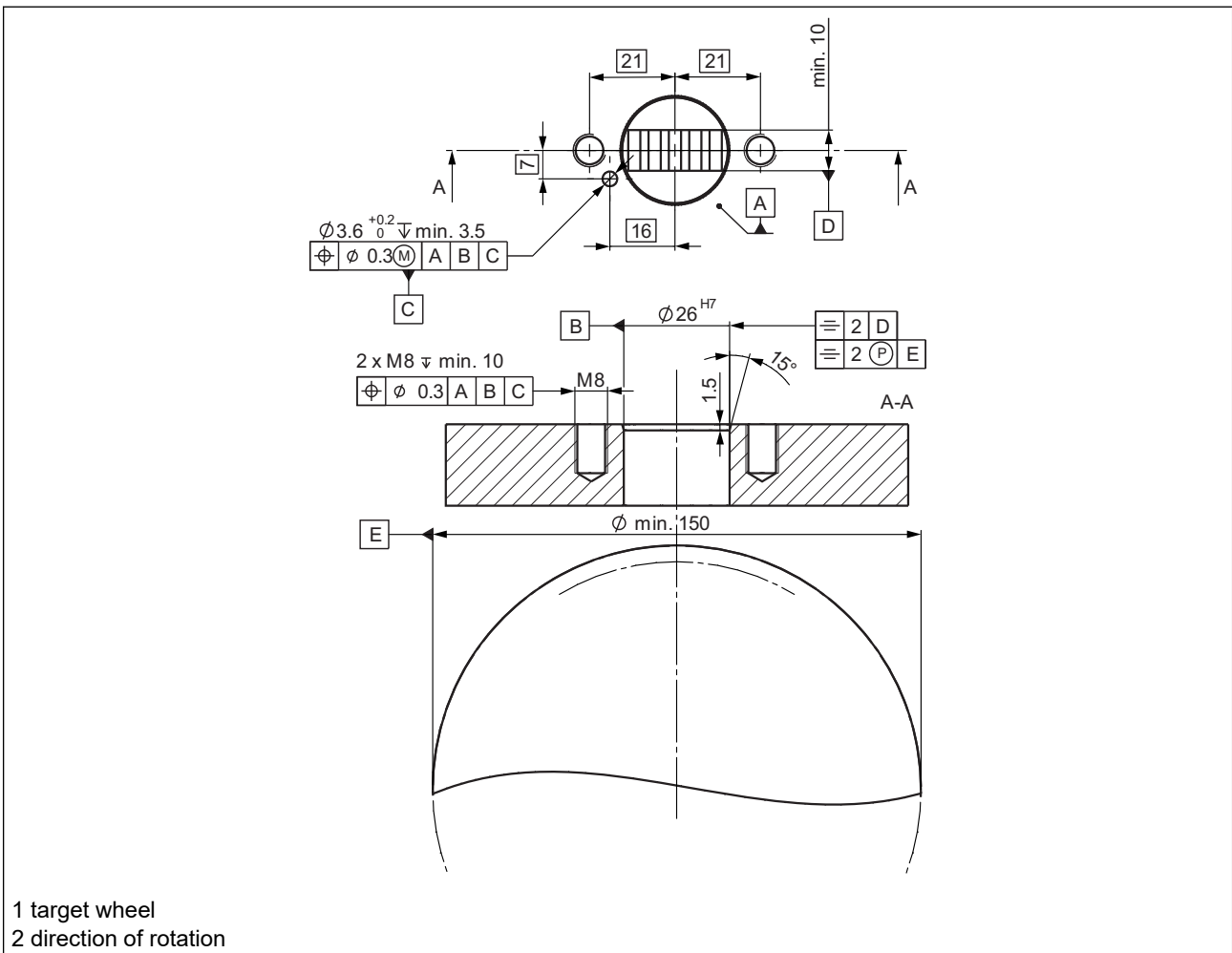

(1) With view on the visible surface signals are output in forward direction when the target wheel rotates clockwise.

Air gap table

Air gap table

Module	Permissible air gap	Nominal air gap	Permissible radial runout max.
1.00	0.2 to 0.8 mm	0.5 mm	± 0.3 mm
1.25			
1.50	0.2 to 1.3 mm	0.7 mm	
1.75			
2.00	0.2 to 1.5 mm	0.7 mm	
2.25			
2.50			
2.75			
3.00			
3.25			
3.50			

Type code

Type code GEL 247

247	Signal pattern	
	E	1-channel square-wave signals
	F	1-channel square-wave signals and inverse signals
	S	1-channel square-wave signals with direction signal
	V	2-channel square-wave signals shifted by 90°
	X	2-channel square-wave signals shifted by 90° and inverse signals
	D	2-channel square-wave signals shifted by 90°, galvanically isolated
	H	2-channel square-wave signals shifted by 90° and inverse signals, galvanically isolated
	Signal output	
	-	Voltage
	I	Current 7 ... 14 mA (with signal patterns D, E and V only)
	M	Voltage with standstill voltage 7 V (with signal patterns D and E only)
	Cable outlet	
	F	straight, cable length 2 m
	G	lateral, cable length 2 m
	S	straight, customised ready-made cabling
	T	lateral, customised ready-made cabling
	Module m	
	M100	m = 1.00
	M125	m = 1.25
	M150	m = 1.50
	M175	m = 1.75
	M200	m = 2.00
	M225	m = 2.25
	M250	m = 2.50
	M275	m = 2.75
	M300	m = 3.00
	M325	m = 3.25
	M350	m = 3.50
	Used internally	
		0

Notes: For a special customized version a Y-No. will be created. A special version is manufactured according to a drawing or application description and could differ from the technical standard specification.

We manufacture for you upon request:

Examples for the sensor end, preferred types

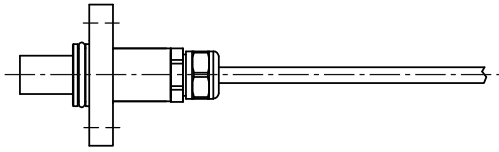

Standard, cable outlet straight

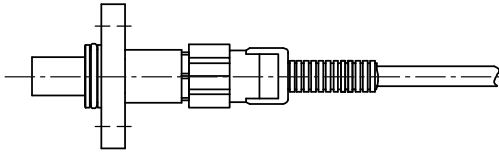

*ABB flexible conduit, cable outlet straight
Type XPCST-12BG*

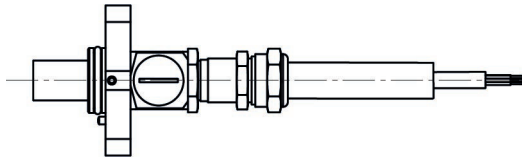

*Anaconda Sealtite, cable outlet straight
Type HFX-V0 348.010.1 5/16"*

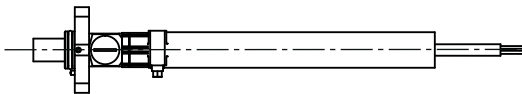

*EATON hose, cable outlet straight
Type EC 045-8*

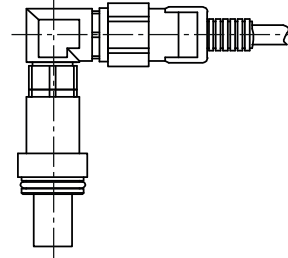

Cable outlet with 90 ° angle and Wellrohr

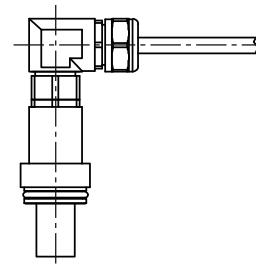

Cable outlet with 90 ° angle

Example for cable end, preferred types

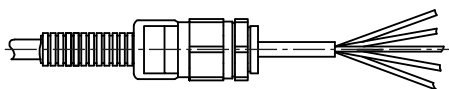

Flexible conduit and flying lead

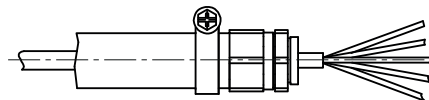

Rubber sleeve and flying lead

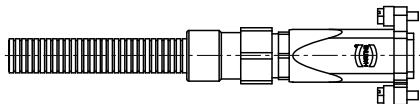

Example

Connection assignment Harting connector HAN HPR for D and H signal, preferred type

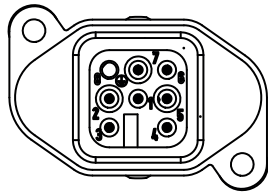

Connection assignment		
Pin	Function	Colour
1	$U_B = 10 \dots 30 \text{ V DC}$	red
2	0 V GND	blue
3	Channel 1	yellow
4	n. c.	n. c.
5	$U_B = 10 \dots 30 \text{ V DC}$	brown
6	0 V GND	black
7	Channel 2	white
8	Screen	violet

Connection assignment Harting connector HAN HPR for V and X signal, preferred type

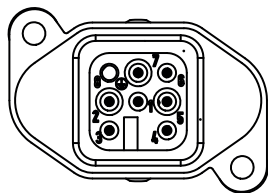

Connection assignment		
Pin	Function	Colour
1	$U_B = 10 \dots 30 \text{ V DC}$	red
2	0 V GND	blue
3	Channel 1	yellow
4	Channel 2	white
5	Channel 1 invers	black
6	Channel 2 invers	brown
7	Screen	violet
8	n. c.	n. c.

If you decide to task us with the assembly of our speed sensors with cable protection and connectors, we recommend the usage of the preferred types shown. The materials required are tried-and-tested in the field in large numbers and are always in stock. In this way the shortest possible delivery times can be achieved due to the best material availability and the large procurement volumes ensure the lowest possible prices.

If you would like assistance with the specification of the product you require, contact our sales team at support@lenord.de or on +49(0)208 9963-215.

Notes:



Lenord, Bauer & Co. GmbH
Dohlenstraße 32
46145 Oberhausen, Germany
Phone: +49 208 9963-0
Fax: +49 208 676292
Internet: www.lenord.com
E-Mail: info@lenord.de